

REV
NC
DTM06-12S*

REVISIONS			
SYM	DESCRIPTION	DATE	APPROVED
NC	NEW RELEASE PER E.O. P17240	4-19-01	RDR

7. SEE SHEET 2 FOR OTHER KEY ARRANGEMENTS.
6. MATERIAL - HOUSING: PLASTIC; GROMMET: RUBBER.
5. THIS PLUG MATES WITH DTM04-12P*-**** RECEPTACLE.
(* = A,B,C,D KEYS; **** = ALL MODIFICATIONS)
4. FOR CONTACT AND WIRE PERFORMANCE AND APPLICATION CHARACTERISTICS SEE ENVELOPE DRAWING 0425-015-0000.
3. SECONDARY WEDGE LOCK SOLD SEPARATELY: WM-12S.
2. DIMENSION TOLERANCE: ±.025 [.64].
1. DIMENSIONS ARE IN INCHES [mm].

NOTES: UNLESS OTHERWISE SPECIFIED

CONTACT SIZE	MIN. INSUL. O.D.	MAX. INSUL. O.D.	WIRE RANGE [mm ²] REF ONLY
20	.053 [1.35]	.120 [3.05]	16-22 AWG [1.0-0.5]

SIGNATURE & DATE		PLUG 12 CONTACTS, SIZE 20 A,B,C,D KEYS DTM SERIES	CP	MATL. CODE
DR	J. APOSTOL 17APR2001		The Deutsch Company DEUTSCH I.P.D. 3850 INDUSTRIAL AVE. HEMET, CALIF. 92545	
CHK	R. Meyer 4/18/01		B	DTM06-12S*
PE	D. Meyer 4/17/01			CODE 11139
APPD	R. Reed 4-19-01	ENVELOPE	DWG SIZE	
SCALE	NONE	WT		

REV
NC DTM06-12S*

REVISIONS			
SYM	DESCRIPTION	DATE	APPROVED
	SEE SHEET ONE	4-19-01	RDR

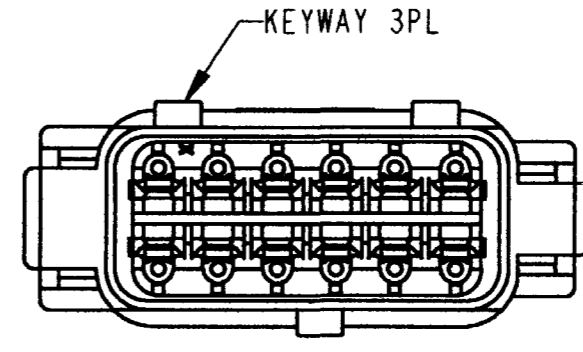
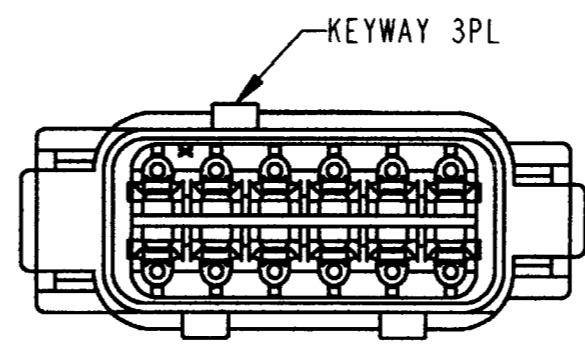
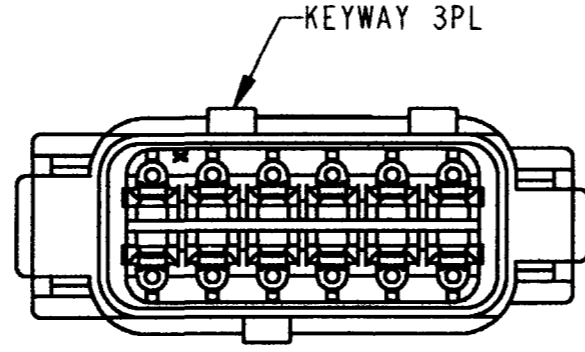
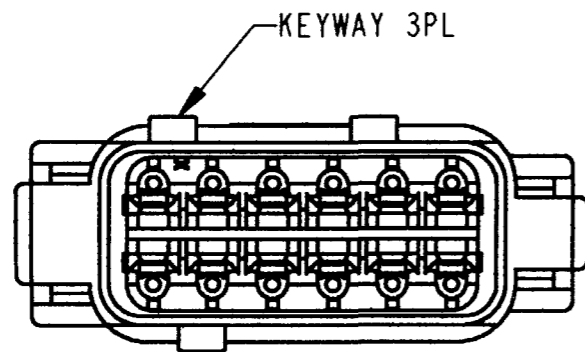
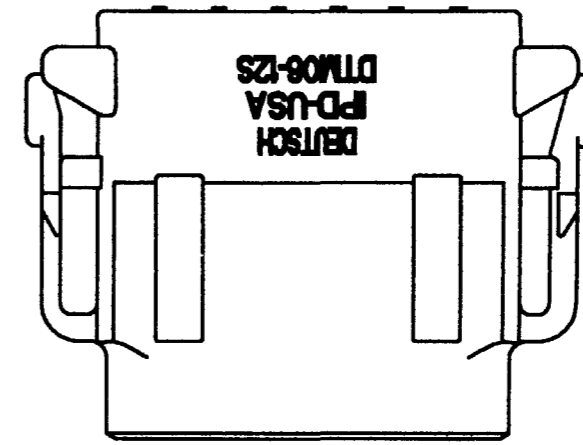
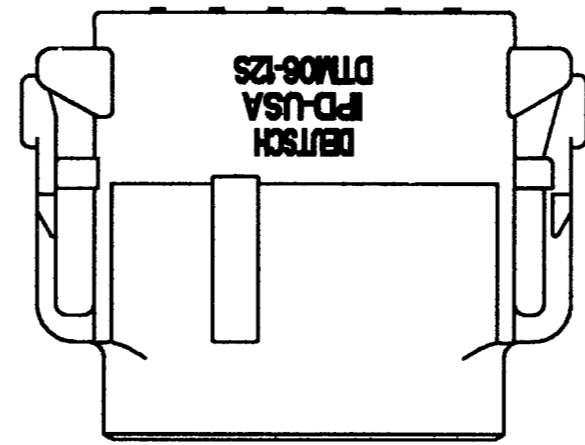
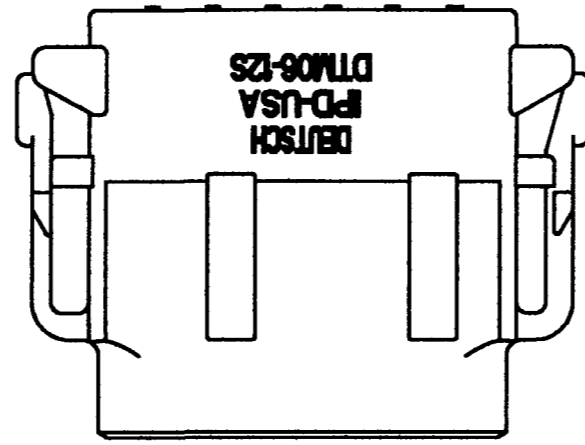
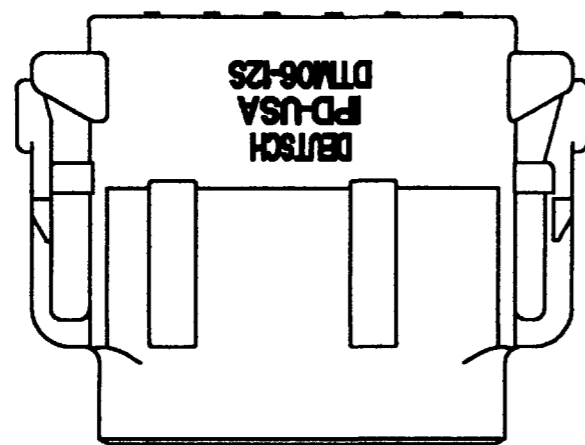

DTM06-12SA
KEY -A-
COLOR: GREY

DTM06-12SB
KEY -B-
COLOR: BLACK

DTM06-12SC
KEY -C-
COLOR: GREEN

DTM06-12SD
KEY -D-
COLOR: BROWN

NOTES:

SIGNATURE & DATE		PLUG 12 CONTACTS, SIZE 20 A,B,C,D KEYS DTM SERIES	CP	MATL. CODE	
DR	J. APOSTOL 17APR2001		The Deutch Company DEUTSCH I.P.D. 3850 INDUSTRIAL AVE. HEMET, CALIF. 92545		
CHK	Rmly 4/18/01		B	DTM06-12S*	
PE	D Meyer 4/17/01			DWG SIZE	11139
APPD		ENVELOPE			
SCALE	NONE	WT			