

REV NC DTM06-12S*

REVISIONS			
SYM	DESCRIPTION	DATE	APPROVED
NC	NEW RELEASE PER E.O. P17240	4-19-01	RDR

- 7. SEE SHEET 2 FOR OTHER KEY ARRANGEMENTS.
- 6. MATERIAL - HOUSING: PLASTIC; GROMMET: RUBBER.
- 5. THIS PLUG MATES WITH DTM04-12P*-**** RECEPTACLE. (* = A,B,C,D KEYS; **** = ALL MODIFICATIONS)
- 4. FOR CONTACT AND WIRE PERFORMANCE AND APPLICATION CHARACTERISTICS SEE ENVELOPE DRAWING 0425-015-0000.
- 3. SECONDARY WEDGE LOCK SOLD SEPARATELY: WM-12S.
- 2. DIMENSION TOLERANCE: $\pm .025$ [.64].
- 1. DIMENSIONS ARE IN INCHES [mm].

NOTES: UNLESS OTHERWISE SPECIFIED

CONTACT SIZE	MIN. INSUL. O.D.	MAX. INSUL. O.D.	WIRE RANGE [mm ²] REF ONLY ⁴
20	.053 [1.35]	.120 [3.05]	16-22 AWG [1.0-0.5]

SIGNATURE & DATE	
DR	J. APOSTOL 17APR2001
CHK	R. Meyer 4/18/01
PE	D. Meyer 4/17/01
APPD	R. Reed 4-19-01
SCALE	NONE WT _____

PLUG
12 CONTACTS, SIZE 20
A, B, C, D KEYS
DTM SERIES

ENVELOPE

CP	MATL. CODE
The Deutsch Company DEUTSCH I.P.D. 3850 INDUSTRIAL AVE. HEMET, CALIF. 92545	
B	DTM06-12S*
DWG SIZE	CODE 11139 SHEET 1 OF 2

REV
NC **DTM06-12S***

REVISIONS			
SYM	DESCRIPTION	DATE	APPROVED
	SEE SHEET ONE	4-19-01	RDR

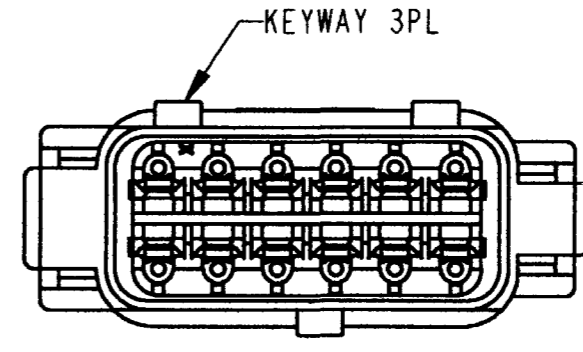
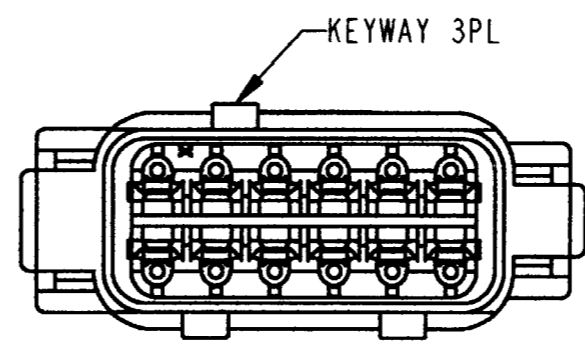
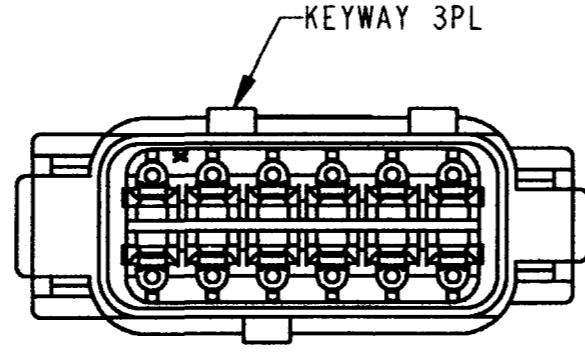
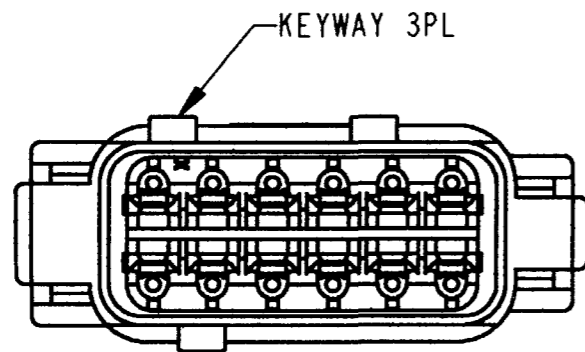
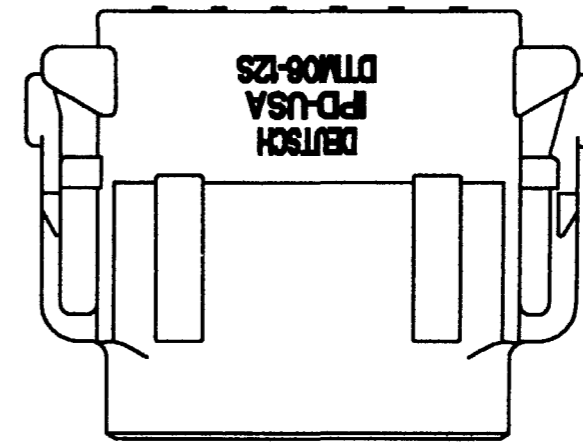
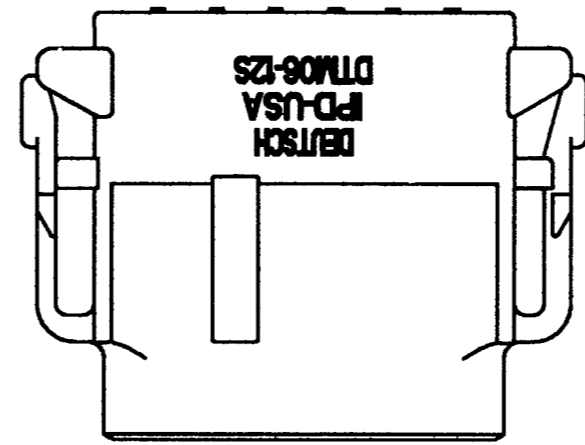
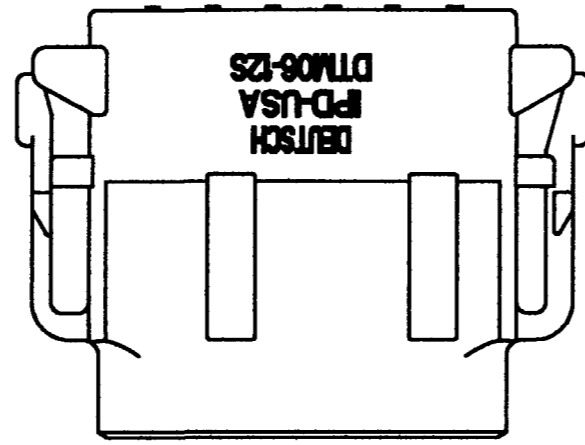
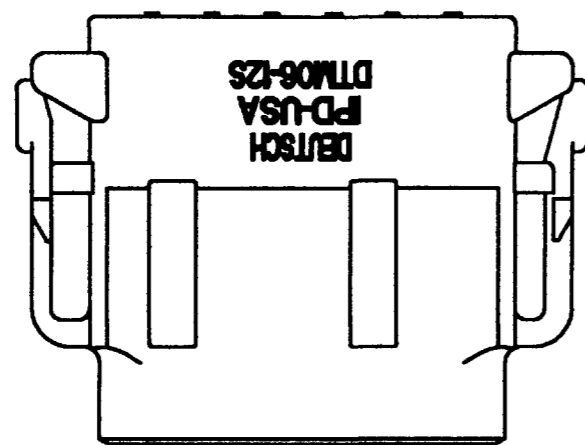

DTM06-12SA
KEY -A-
COLOR: GREY

DTM06-12SB
KEY -B-
COLOR: BLACK

DTM06-12SC
KEY -C-
COLOR: GREEN

DTM06-12SD
KEY -D-
COLOR: BROWN

NOTES:

SIGNATURE & DATE		PLUG 12 CONTACTS, SIZE 20 A,B,C,D KEYS DTM SERIES	CP	MATL. CODE	
DR	J. APOSTOL 17APR2001		The Deutch Company DEUTSCH I.P.D. 3850 INDUSTRIAL AVE. HEMET, CALIF. 92545		
CHK	Rmly 4/18/01		B	DTM06-12S*	
PE	D Meyer 4/17/01			DWG SIZE	11139
APPD		ENVELOPE			
SCALE	NONE	WT			